

# POMAX

SOUL IN *your* HOME



SOFA GUIDE  
2025 - 2026

*I slumped onto the couch,  
kicked off my shoes and cancelled  
my plans for the night - again.*

## Content

<b>SOFA COLLECTION.....</b>	<b>4</b>
Lulu.....	6
Pippa.....	12
Toronto.....	22
Brower.....	28
<b>FABRICS.....</b>	<b>34</b>
Labels.....	36
Overview.....	38
Care instructions.....	42

## Sofa collection

*Discover our curated sofa collection, where thoughtful design meets everyday functionality. Whether you're furnishing a cozy corner or a spacious lounge, Pomax offers products that adapt effortlessly to your lifestyle, and one timeless fixed model for classic comfort.*

*Crafted with care using quality materials, each piece is built to last and designed to elevate your living space, whether you're unwinding, hosting, or simply enjoying the moment.*



EXPLORE  
OUR SOFA  
CONCEPTS AT  
[POMAX.COM](https://pomax.com)



## Lulu

Elegant and timeless, this sofa impresses with its generous proportions and deep seat (75 cm), perfect for lounging. Also available in a more compact version with a 60 cm seat depth.

### Available in three sizes

- L 95 x W 95 cm
- L 95 x W 110 cm
- L 110 x W 110 cm

### Easy to assemble

The modules remain securely in place thanks to the metal clip-on frames. The backrest and base are produced as a single, unified piece.

### Anti-slip

Velcro is provided on the pouf so that the cushion stays neatly positioned on the frame.

### Duck feathers

Its back cushions are filled with the softest duck feathers and siliconized fibre balls, which provide more comfort and a cozy feel.

### Removable fabrics

Both the cover and cushions are easily removable, making them simple to care for over time. The cover can also be purchased separately. Choose between a fixed or loose cover, and explore the available fabrics on page 38.

### Top-quality linen

Most of our linens are crafted by the renowned Belgian brand Libeco, known for its top-quality products.



**corner**  
L 110 x W 110 x H 73 cm



**1-seater**  
L 110 x W 110 x H 73 cm



SOFA LULU - FABRIC OATMEAL

## LULU | MODULES

modular sofa - loose and fixed cover - customizable - many fabric options

**1-seater**

L 95 x W 95 x H 73 cm  
L 95 x W 110 x H 73 cm  
L 110 x W 110 x H 73 cm

**corner (left/right)**

L 95 x W 95 x H 73 cm  
L 95 x W 110 x H 73 cm  
L 110 x W 110 x H 73 cm

**ottoman**

L 95 x W 95 x H 47 cm  
L 110 x W 70 x H 47 cm  
L 110 x W 110 x H 47 cm

# TECHNICAL SHEET

POUF 95

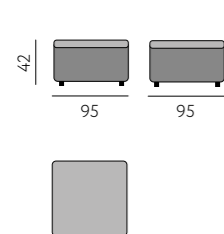

SINGLE SEAT 95

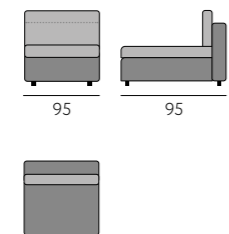

CORNER 95

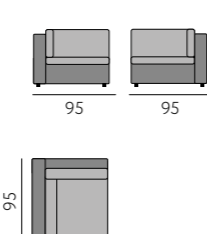

POUFS 95 OR 110

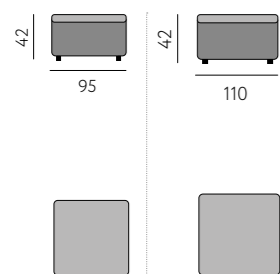

SINGLE SEAT 95 x 110

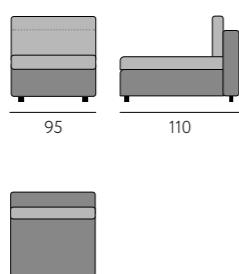

CORNER 95 x 110

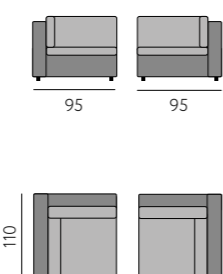

POUF 110

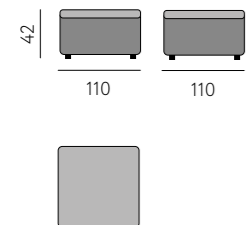

POUF 110 x 70

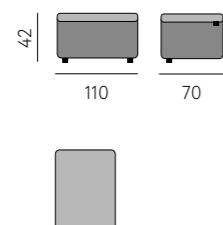

SINGLE SEAT 110

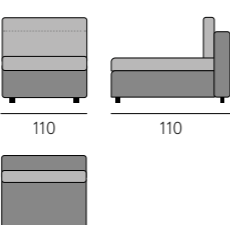

CORNER 110

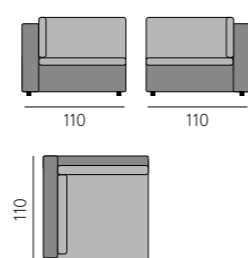

SOFA LULU - FABRIC CAFFE

**Frame**

Crafted from particleboard, solid pine and beech, the frame is finished with raw fiberboard and strengthened with sinuous (zig-zag) springs.

**Seating**

The seating is equipped with a pocket spring unit (70 mm) integrated into the frame, offering lasting comfort and support.

**Seat cushions**

The seating cushion is carefully constructed with a layered filling: they feature in the top and bottom HR-3010 (30 mm) and in the centre HR-5030 (30 mm) high-resilience foam. The entire cushion is wrapped in 200 g/m<sup>2</sup> polyester wadding for extra softness. All cushions are included with a fully removable cover.

**Back and armrest cushions**

The back and armrest cushions are filled with a blend of 40% feathers and 60% siliconized fibre balls.

**Modular elements**

The junction of the 2 elements is done using the metallic crocodile clips placed under these elements. There are no connecting elements on the pouf.

**Upholstery**

The sofa is upholstered with either a loose or fixed fabric cover, which can be removed easily using velcro.

- A **Seat:** pocket-spring unit (70 mm)
- B **Seat cushion:**
  - Top + bottom layer: foam HR-3010 (30 mm)
  - Middle layer: foam HR-5030\* (30 mm)
- C **Back and armrest cushions:** feathers (40%) and siliconized fibre balls (60%)
- D **Frame:** particleboard (15 mm), solid pine and beech, and raw fiberboard (HDF)
- E **Legs:** solid wood (H 5 cm)

\*High-resilience foam with a density of 50 kg/m<sup>3</sup> and a medium firmness of 30.

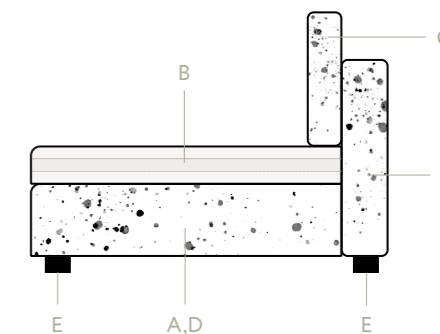



## Pippa

Discover our Pippa non-modular sofa concept, a blend of style and everyday comfort. The loose cover adds an effortlessly chic yet refined appearance to the sofa.

### Available in three sizes

- 1-seater
- 2,5-seater
- 4-seater

### Easy to assemble

The 4-seater sofa is split in two sections, in order to facilitate transportation, yet they remain securely in place thanks to the metal clip-on frame. The backrest and base are produced as a single, unified piece.

### Duck feathers

For enhanced comfort, we've included back cushions filled with duck feathers.

### Removable fabrics

Both the cover and cushions can be easily removed, allowing you to look after them over time. The cover is also available to purchase separately. Pippa comes in 6 different fabrics, discover them on page 38.

### Top-quality linen

Most of our linens are crafted by the renowned Belgian brand Libeco, known for its top-quality products.



4-seater  
L 280 x W 110 x H 65 cm





SOFA PIPPA - FABRIC CAFFE

# PIPPA | SOFAS

non-modular sofas - loose cover - many fabric options



single seat  
L 75 x W 75 x H 65 cm



2,5-seater  
L 220 x W 110 x H 65 cm



4-seater  
L 280 x W 110 x H 65 cm

1-SEATER

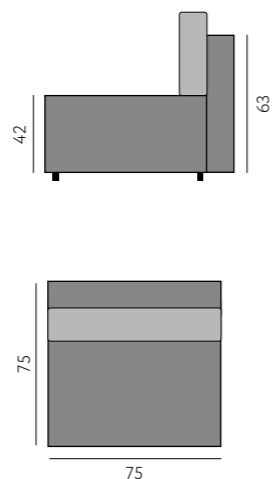

2,5-SEATER

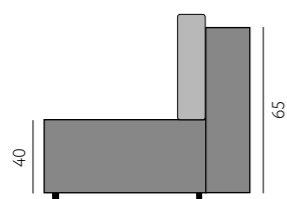

4-SEATER

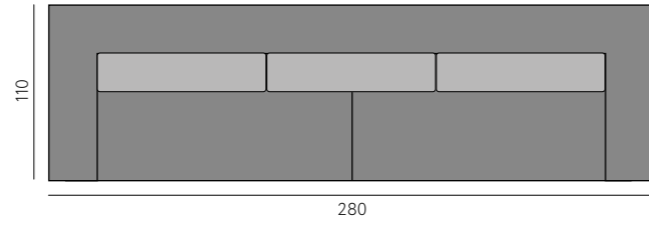
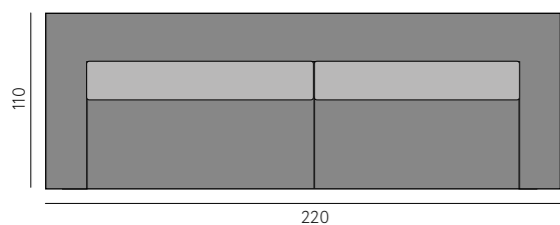
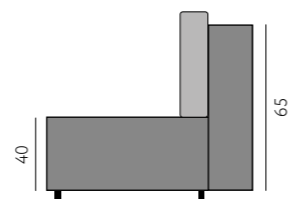

SOFA PIPPA - FABRIC PUROLINO

**Structure**

Fully removable cover on a structure made of massive beech and particle boards recovered with a high resilient (HR) foam of 30 kg/m<sup>3</sup> density. The legs are removable and in solid wood.

**Seating**

Seating part supported by a double combined system of zigzag springs and pocketed springs placed under a thick layer of High Resilience Foam of 30 kg/m<sup>3</sup> density.

**Back cushion**

The back cushion has a fully removable cover. The core consists of high resilient foam of 16 and 23 kg/m<sup>3</sup> density and is covered with a layer of encapsulated feathers.

**Modular elements**

The two elements of the 4-seater sofa are joined together with metallic crocodile clips placed underneath.

- A **Seat filling:** polyurethane foam T3030, cold foam, boxspring, feathers mixed with silicone balls, mixed with foam sticks
- B **Back cushion filling:** filled with duck feathers
- C Frame springs
- D **Frame material:** solid beech wood
- E **Back material:** wood based elements (chipboard, fireboard) of frame
- F **Legs:** wood (H 2,5 cm)

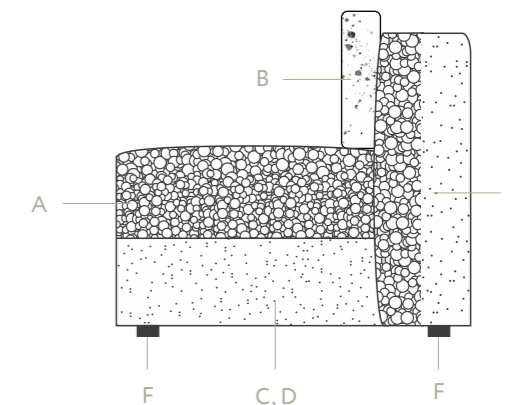



A dark, textured wooden side table with a green lamp on top.

A green lamp with a textured shade.

A green sofa with two beige pillows.

A dark, textured wooden coffee table with a glass on top.

A brown vase containing greenery.

A dark, textured wooden side table.

A beige upholstered chair with wooden legs.

A wooden bookshelf with books and decorative objects.

Books on the bookshelf.

Decorative objects on the bookshelf.

Decorative objects on the bookshelf.

A wall-mounted light fixture.

A wall-mounted light fixture.



SOFA TORONTO - FABRIC ENJOY ME 19

## Toronto

As a central piece of furniture of living rooms and spaces, a sofa is not something that you choose randomly. To suit all needs, Pomax introduces Toronto, one of our modular sofa concepts.

### Easy to assemble

The modules remain securely in place thanks to the metal clip-on frames. The backrest and base are produced as a single, unified piece. Choose the armrest position - left or right - modular or fixed securely to the corresponding module.

### Anti-slip

Anti-slip fabric on the frame and seat cushions helps keep the cushions securely in place. The back cushions are zipped to the frame, ensuring a fixed, ergonomic position and a neat, attractive appearance.

### Various fabrics

Toronto is available in 15 different fabrics, allowing you to choose the perfect texture and colour to complement your home decor. Check them on page 40.



single seat  
L 95 x W 100 x H 84 cm



armrest  
L 100 x W 15 x H 56 cm



## TORONTO | MODULES

modular sofa - fixed cover - customizable - many fabric options



**single seat**  
L 95 x W 100 x H 84 cm



**double seat**  
L 190 x W 100 x H 84 cm



**corner (left/right)**  
L 100 x W 100 x H 84 cm



**longchair**  
L 95 x W 170 x H 84 cm



**ottoman**  
L 100 x W 70 x H 42 cm  
L 100 x W 95 x H 42 cm



**armrest (left/right, fixed/in option modular)**  
L 100 x W 15 x H 56 cm

# TECHNICAL SHEET

## SINGLE SEAT

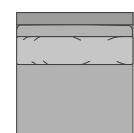
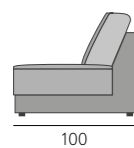
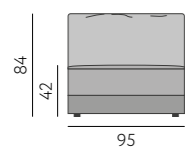

## DOUBLE SEAT

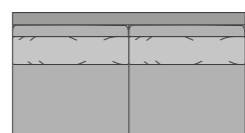
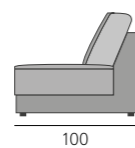
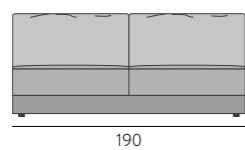

## CORNER

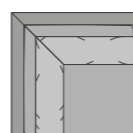
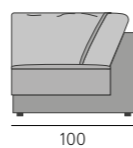
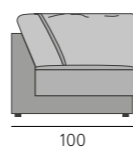

## LONGCHAIR

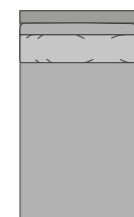
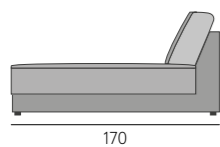
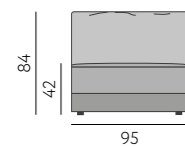

## POUF (70 cm)

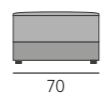
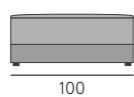

## POUF (95 cm)

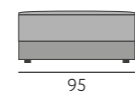
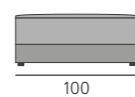

## ARMREST

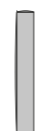
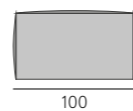
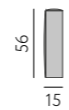

SOFA TORONTO - FABRIC ENJOY ME 19

YOU CAN CHOOSE BETWEEN THE LEFT OR RIGHT SIDE OF THE ARMREST

- A **Seat filling:** polyurethane foam T3030, cold foam, boxspring, feathers mixed with silicone balls and foam sticks
- B **Back filling:** silicone balls lux mixed with foam sticks
- C Frame springs
- D **Frame material:** solid beech wood
- E **Back material:** wood based elements (chipboard, fireboard) of frame
- F **Legs:** wood (H 2,5 cm)

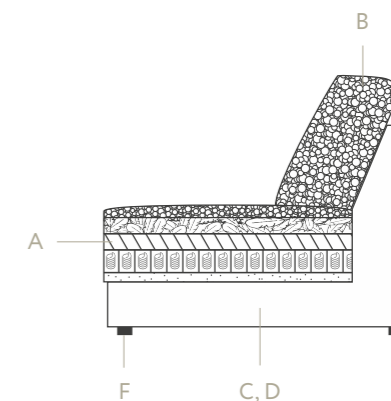



SOFA BROWER - FABRIC LINCOLN 03

## Brower

The Brower modular sofa is a versatile and customizable seating solution that adapts effortlessly to your living space.

### Many different configurations

- 3-seater
- Corner setup
- L-shape
- ...

### Various fabrics

Numerous fabrics are available, allowing you to choose the perfect texture and colour to complement your home decor. Check them on page 40.



longchair  
L 133 x W 95 x H 72 cm



single seat  
L 95 x W 95 cm



SOFA BROWER - FABRIC LINCOLN 03

## BROWER | MODULES

modular sofa - fixed cover - customizable - many fabric options



single seat  
L 95 x W 95 x H 72 cm



ottoman  
L 95 x W 95 x H 42 cm



corner (left)  
L 95 x W 95 x H 72 cm



double seat (left)  
L 215 x W 95 x H 72 cm



longchair (-back/left)  
L 133 x W 95 x H 72 cm



longchair (+back/left)  
L 108 x W 170 x H 72 cm



corner (right)  
L 95 x W 95 x H 72 cm



double seat (right)  
L 215 x W 95 x H 72 cm



longchair (-back/right)  
L 133 x W 95 x H 72 cm



longchair (+back/right)  
L 108 x W 170 x H 72 cm

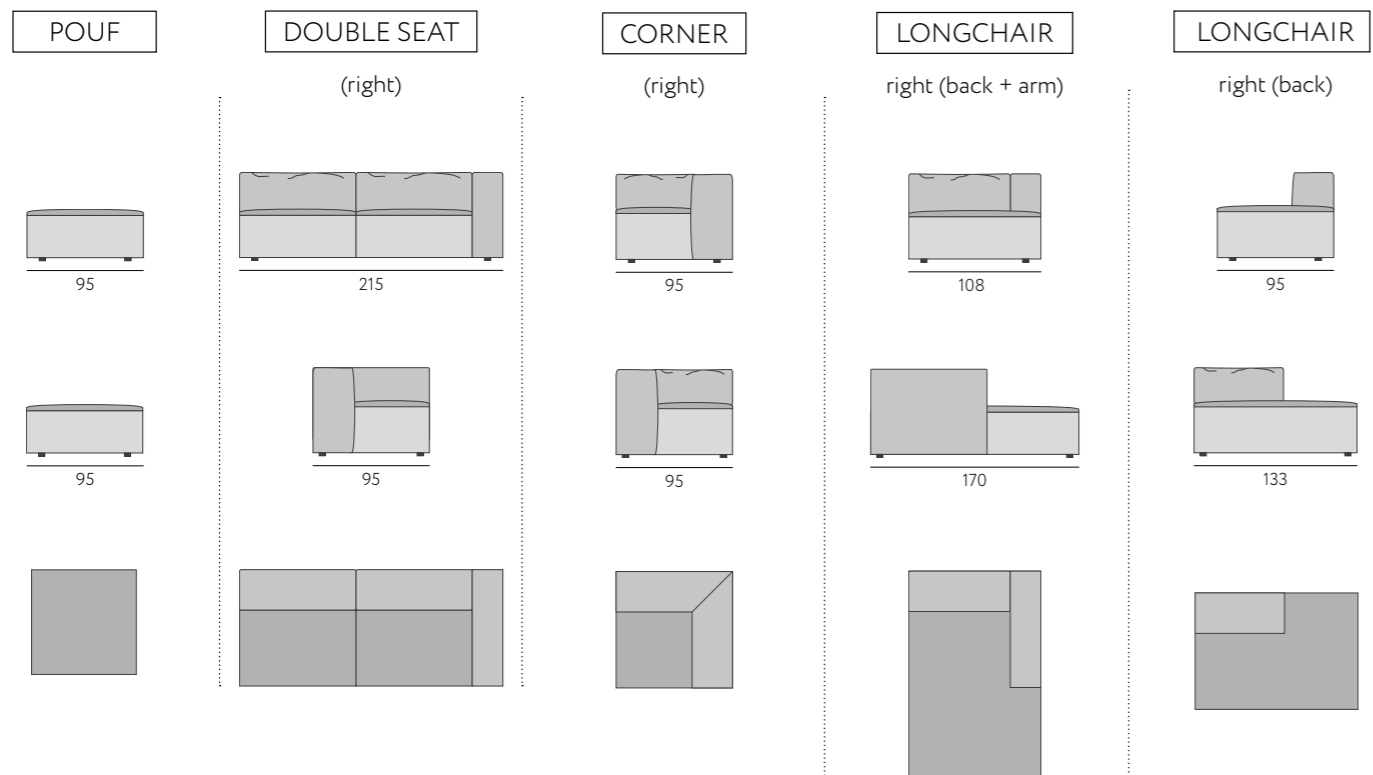
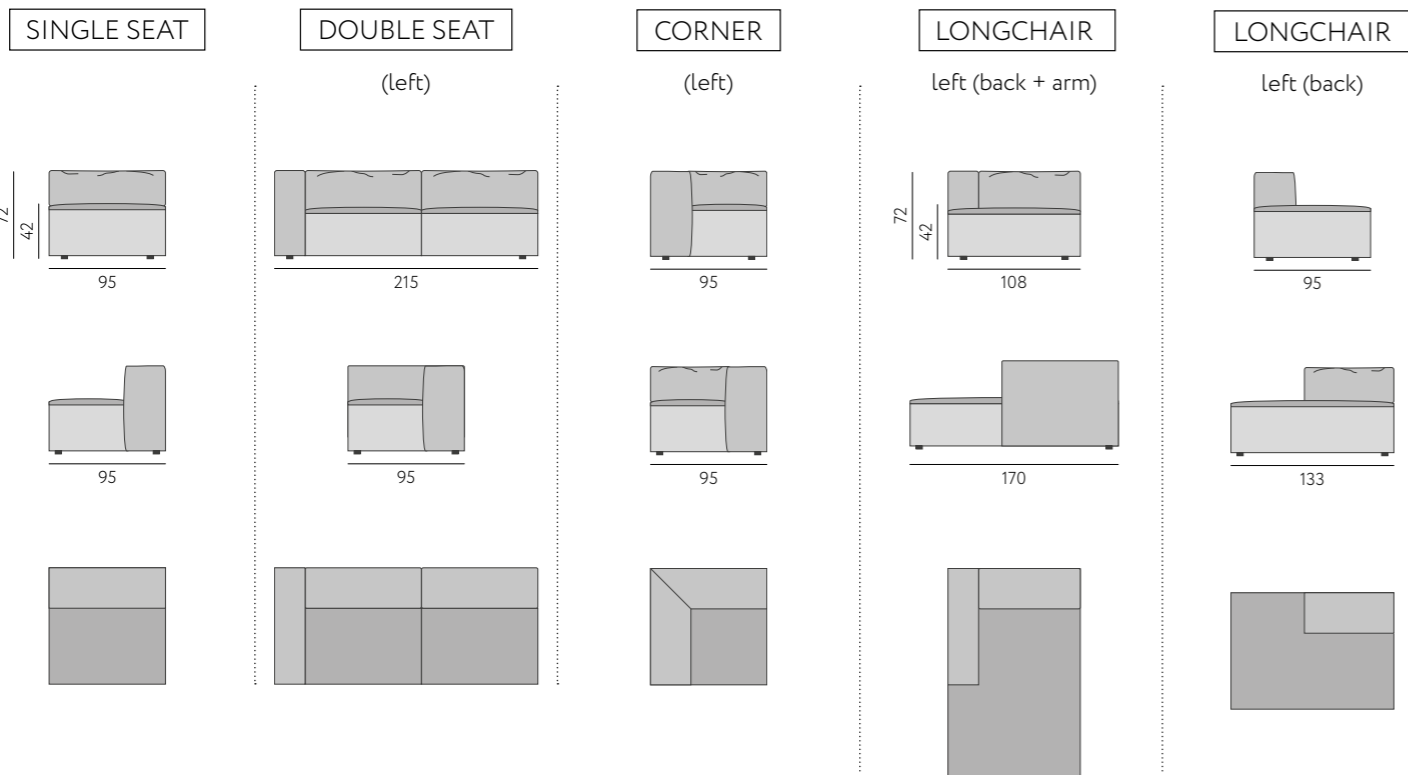

**Easy to assemble**

The sofa is divided into two distinct sections, providing a flexible seating arrangement while maintaining a cohesive look. Thanks to the sturdy metal clip-on frame, the components remain securely in place, ensuring stability and preventing any unwanted movement.

**Comfortable seating**

Thanks to its silicone ball filling, the Brower sofa might just be the most comfortable one you'll ever experience.

- A **Seat filling:** HR foam 3536, silicone balls lux mixed with foam sticks
- B **Back filling:** silicone balls lux mixed with foam sticks, polyurethane
- C Frame springs
- D **Frame material:** solid beech wood
- E **Back material:** wood based elements (chipboard, fireboard) of frame
- F **Legs:** wood (H 2,5 cm)

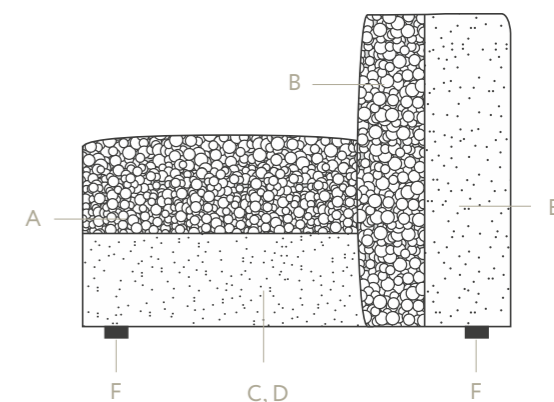

# Fabrics

*Our fabrics are suitable for personal and professional use. That is why it includes a wide range of covering fabrics.*

*This collection is versatile and can be used for sofas and chairs (Mercy & Korfu). However, it's important to note that not every fabric is suitable for every type of furniture.*



DISCOVER  
ALL OUR  
FABRICS AT  
[POMAX.COM](https://www.pomax.com)



## Fabric specifications



### Easy to clean

At the production stage, the fibres are covered with a special finish that protects the fabric from dirt penetration. Thanks to this, all stains are quickly and efficiently cleaned. Check our care instructions and products on page 3.



### Liquid-repelling surfaces

A technology of covering the fabric with a special hydrophobic coating that effectively avoids the absorption of spilled liquids, leaving drops on the surface of the material.



### The environment in our mind

Recycled fabrics demonstrate our planet's care by sustainably cutting water and electricity use, and lowering CO<sup>2</sup> emissions.

### Natural fabric

Linen is a natural fabric and not UV-resistant, so to preserve its beauty we recommend limiting prolonged exposure to direct sunlight.

### OEKO-TEX

OEKO-TEX is a certificate that confirms high quality and safety of textile products that is awarded by an independent research institute. Textiles that have been tested for presence of harmful substances, are free from prohibited chemicals, PFC, allergenic dyes, azodyes and heavy metals. OEKO-TEX proves that our products are safe and do not constitute hazard to their users and the natural environment.

*You can find these labels and their corresponding fabrics also in our Fabrics Guide.*

## Fabrics suitable for sofas Pippa & Lulu

Loose covers for Pippa, fixed and loose ones for Lulu.  
Made of 100% linen.



Oyster (cat 6)



Oatmeal (cat 6)

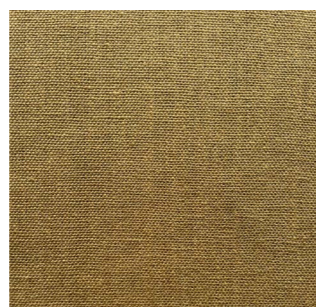

Curry (cat 5)



Caffè (cat 5)

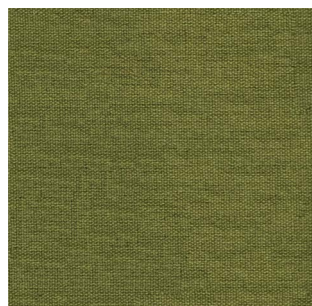

Pioppo (cat 6)

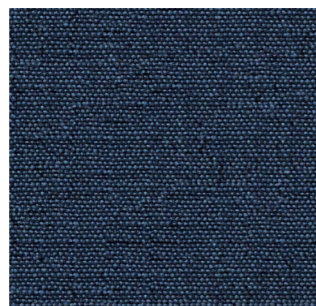

Purolino (cat 9)

## Material compositions

These fabrics are categorised from 5 to 9. The higher the category, the more premium the fabric segment.

### CAT 5 | Caffè ●

Available for Pippa (loose cover) & Lulu (fixed & loose cover).

<b>Material</b>	<b>Martindale test</b>	<b>Extra</b>
100% linen	20.000 cycles	Made in Italy



### CAT 5 | Curry ●

Available for Pippa (loose cover) & Lulu (fixed & loose cover).

<b>Material</b>	<b>Martindale test</b>	<b>Extra</b>
100% linen	20.000 cycles	Made in Italy



### CAT 6 | Oyster ●

Available for Pippa (loose cover) & Lulu (fixed & loose cover).

<b>Material</b>	<b>Martindale test</b>	<b>Extra</b>
100% linen	> 30.000 cycles	Made in Belgium (Libeco)



### CAT 6 | Oatmeal ●

Available for Pippa (loose cover) & Lulu (fixed & loose cover).

<b>Material</b>	<b>Martindale test</b>	<b>Extra</b>
100% linen	20.000 cycles	Made in Belgium (Libeco)



### CAT 6 | Pioppo ●

Available for Pippa (loose cover) & Lulu (fixed & loose cover).

<b>Material</b>	<b>Martindale test</b>	<b>Extra</b>
100% linen	20.000 cycles	Made in Italy



### CAT 9 | Purolino ●

Available for Pippa (loose cover) & Lulu (fixed & loose cover).

<b>Material</b>	<b>Martindale test</b>	<b>Extra</b>
100% linen	20.000 cycles	Made in Italy



# Fabrics suitable for sofas Toronto & Brower

Fixed covers only.



Abriamo (cat 1)

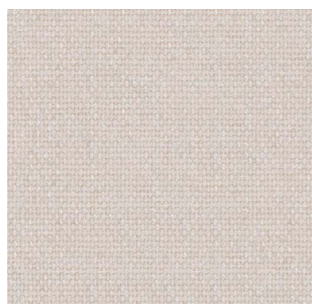

Enjoy Me 01 (cat 1)



Lincoln 03 (cat 1)



Bloom 06 (cat 2)



Nebbia 09 (cat 2)

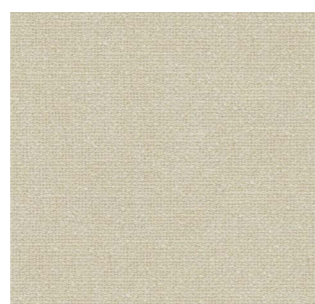

Angola 10 (cat 3)



Enjoy Me 19 (cat 1)



Tulia 05 (cat 2)



Enjoy Me 20 (cat 1)



Vamos 08 (cat 3)



Angola 11 (cat 3)



Enjoy Me 13 (cat 1)



Vamos 07 (cat 3)



Tulia 10 (cat 2)



Vamos 12 (cat 3)

## Material compositions

These fabrics are categorised from 1 to 3. The higher the category, the more premium the fabric segment.

### CAT 1 | Abriamo

Available for sofas Brower, Toronto, Lulu (fixed cover) and chairs Korfu & Mercy.

<b>Material</b> 100% polyester	<b>Martindale test</b> 45.000 cycles	<b>Fire retardant</b> BS 5852: Part 1: 1979 source 0 (cigarette test)
-----------------------------------	---	--

### CAT 1 | Enjoy Me

Available for sofas Brower, Toronto, Lulu (fixed cover) and chairs Korfu & Mercy.

<b>Material</b> 100% polyester	<b>Martindale test</b> 100.000 cycles	<b>Fire retardant</b> BS 5852: Part 1: 1979 source 0 (cigarette test)
-----------------------------------	--	--

### CAT 1 | Lincoln

Available for sofas Brower, Toronto, Lulu (fixed cover) and chairs Korfu & Mercy.

<b>Material</b> 100% polyester	<b>Martindale test</b> 100.000 cycles	<b>Fire retardant</b> BS 5852: Part 1: 1979 source 0 (cigarette test)
-----------------------------------	--	--

### CAT 2 | Bloom

Available for sofas Brower, Toronto, Lulu (fixed cover) and chairs Korfu & Mercy.

<b>Material</b> 93% polyester, 7% cotton	<b>Martindale test</b> 50.000 cycles	<b>Fire retardant</b> BS 5852: Part 1: 1979 source 0 (cigarette test)
---	---	--



### CAT 2 | Nebbia

Available for sofas Brower, Toronto, Lulu (fixed cover) and chairs Korfu & Mercy.

<b>Material</b> 100% polyester	<b>Martindale test</b> 43.000 cycles	<b>Fire retardant</b> BS 5852: Part 1: 1979 source 0 (cigarette test)
-----------------------------------	---	--



### CAT 2 | Tulia

Available for sofas Brower, Toronto, Lulu (fixed cover) and chairs Korfu & Mercy.

<b>Material</b> 100% polyester	<b>Martindale test</b> 90.000 cycles	<b>Fire retardant</b> BS 5852: Part 1: 1979 source 0 (cigarette test)
-----------------------------------	---	--



### CAT 3 | Angola

Available for sofas Brower, Toronto, Lulu (fixed cover) and chairs Korfu & Mercy.

<b>Material</b> 68% polyamide, 29% polyester, 3% viscose	<b>Martindale test</b> 50.000 cycles	<b>Fire retardant</b> BS 5852: Part 1: 1979 source 0 (cigarette test)
---	---	--



### CAT 3 | Vamos

Available for sofas Brower, Toronto, Lulu (fixed cover) and chairs Korfu & Mercy.

<b>Material</b> 47% polyester, 45% polyamide, 8% viscose	<b>Martindale test</b> 35.000 cycles	<b>Fire retardant</b> BS 5852: Part 1: 1979 source 0 (cigarette test)
---	---	--



## All-in-house service

### Products & service

Dutch market leader, with 80 years of experience in stain service, since 2005 also full service, valid for Benelux, France, Germany and Austria.

This is an additional service programme, to be purchased at the same time as the chair, lounge seat or sofa in question, both in fabric and leather.

Important: both must be on one order together.  
Warranty: 5 years.

The package includes:

- A high-quality impregnation spray and cleaner
- Professional advice in case of questions/complaints
- Professional repair at the consumer's home



### Stain service

- Beverage stains (soft drinks, smoothies, alcoholic drinks, breakfast drinks, hot drinks)
- Food stains (sauce, toppings, grease, sweets, meals)
- Natural stains human and animal (sweat, skin grease, blood, urine, vomit, faeces)

How does it work?

- 1 Use the impregnating spray to protect your furniture against stains immediately after purchase.
- 2 If a stain develops, use the cleaner.
- 3 If the stain remains visible, call the customer service number on the service card. This number may also be called in case of construction problems.

### Construction service

- Strengthening and/or filling of fixed seats due to sagging
- Repair or replacement of nosag springs and inner springs
- Elimination of squeaks and creaks
- Fixing of loose connections, knots and spring clips
- Repair and replacement of broken battens

How does it work?

- 1 Call the client service number on the service card included in the box.
- 2 An employee of the internal service comes on site to inspect, repair on site or takes the part with him.
- 3 Delivery of the fixed part.



# POMAX

SOUL IN *your* HOME



SOFA GUIDE 2025 -2026  
[www.pomax.com](http://www.pomax.com)